



POWERSPORTS

EN SKID PLATE INSTALLATION MANUAL

DE MONTAGEANLEITUNG FÜR UNTERBODENSCHUTZ SYSTEM



For: CF Moto X8 H.O. (2018-); X10 (2019-)

2444.6884.1

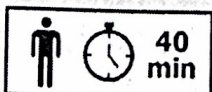

RIVAL4X4USA.COM



EN Regular fasteners
DE Originale montageteile



EN Regular fasteners
DE Originale montageteile



EN Screw a several turns
DE Für wenigen Umdrehungen befestigen



EN Loosen bolts
DE Bolzen lockern

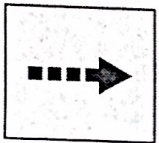

EN Movement Arrow
DE Bewegungsrichtung

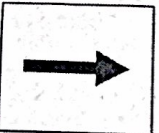

EN Location/Position Arrow
DE Anordnung/Positionsrichtung

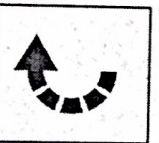

EN Screw Arrow
DE Drehungsrichtung

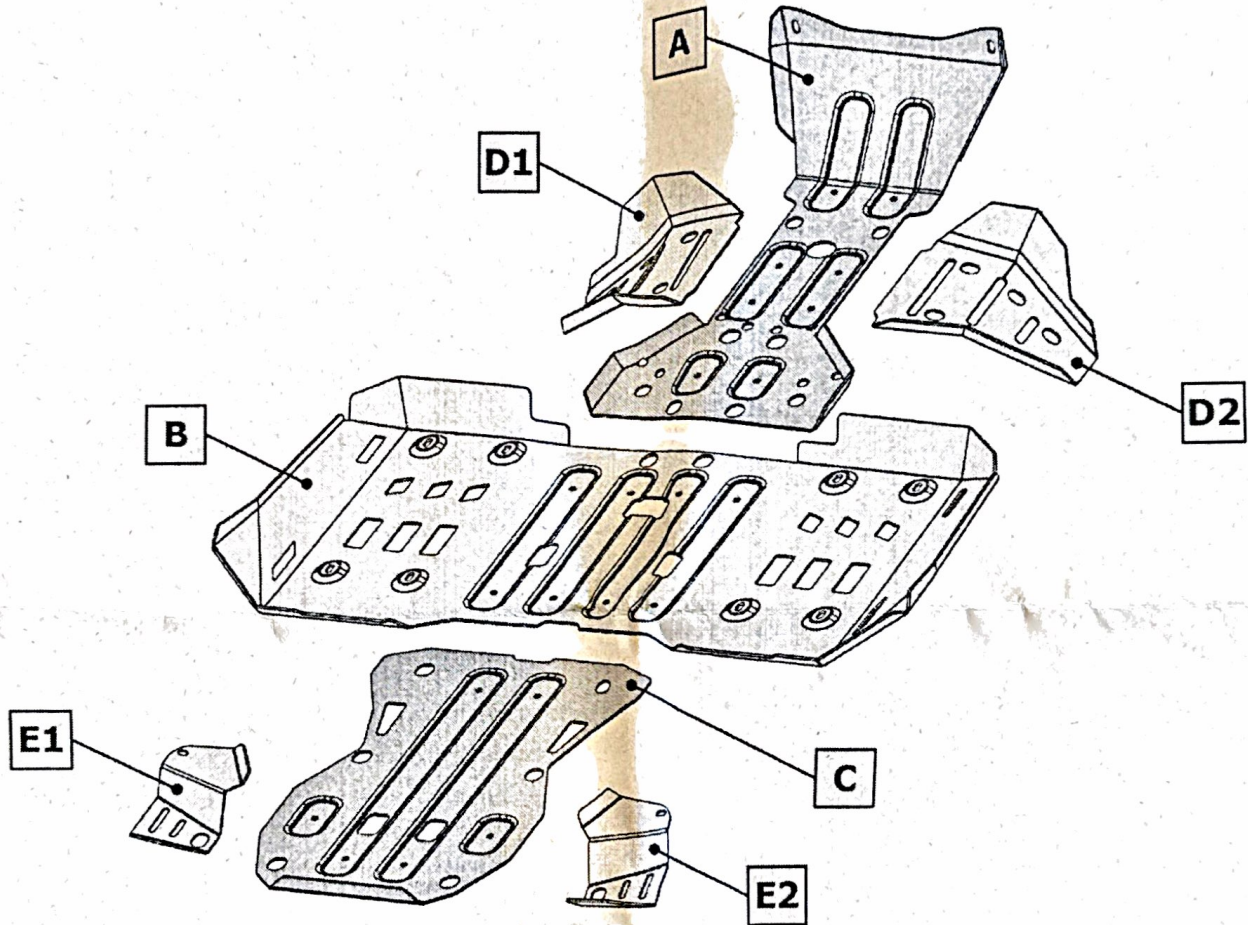
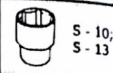
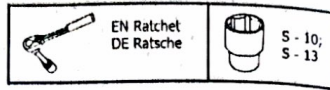

1	x2	2	x1	3	x2	4	x2	5	x2	6	x1
7	x4	8	x2	9	x2	10	x2	11	x15	12	x14
13	x12	14	x1	15	x19	16	x14	17	x13	18	x1
19	x1	20	x1								

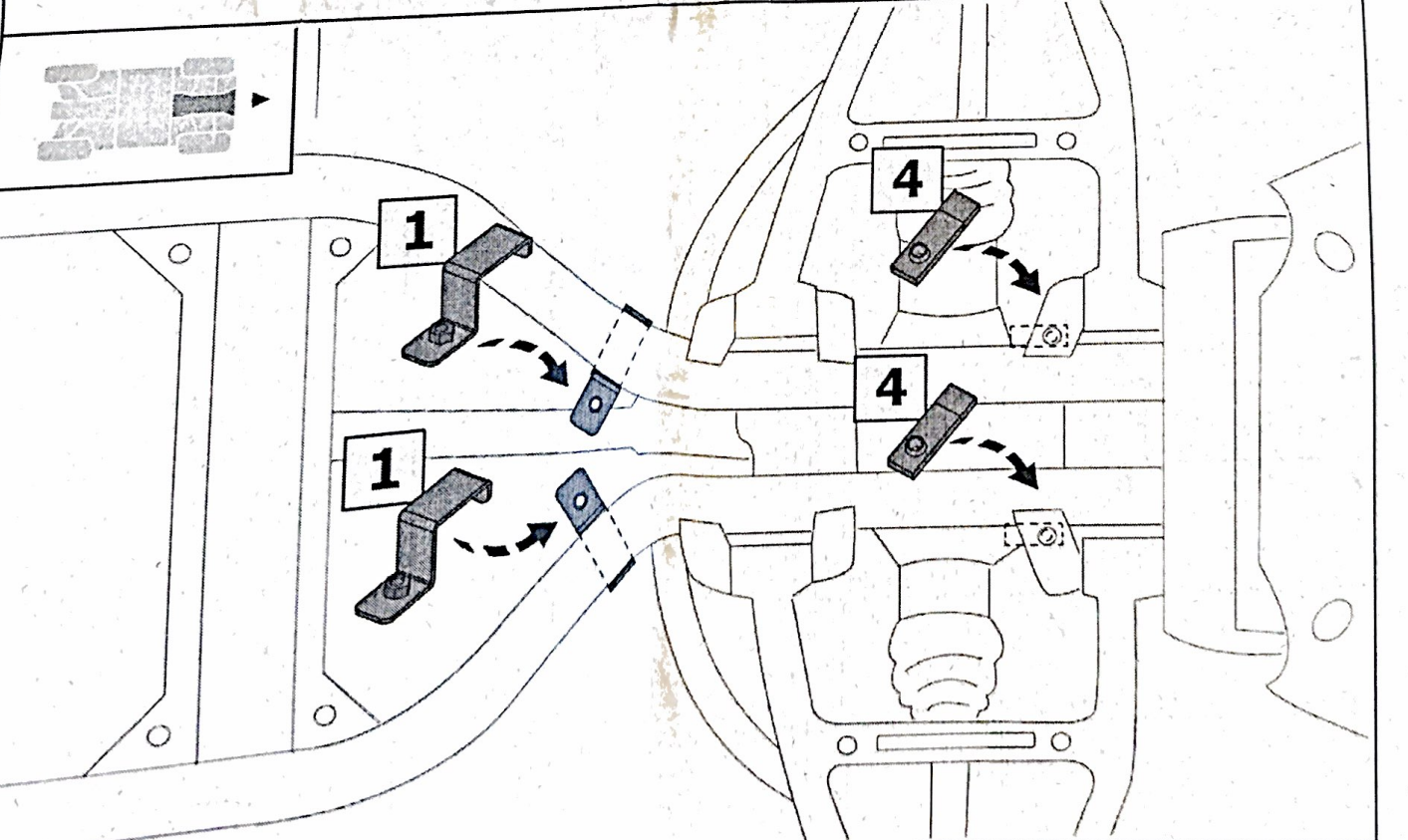
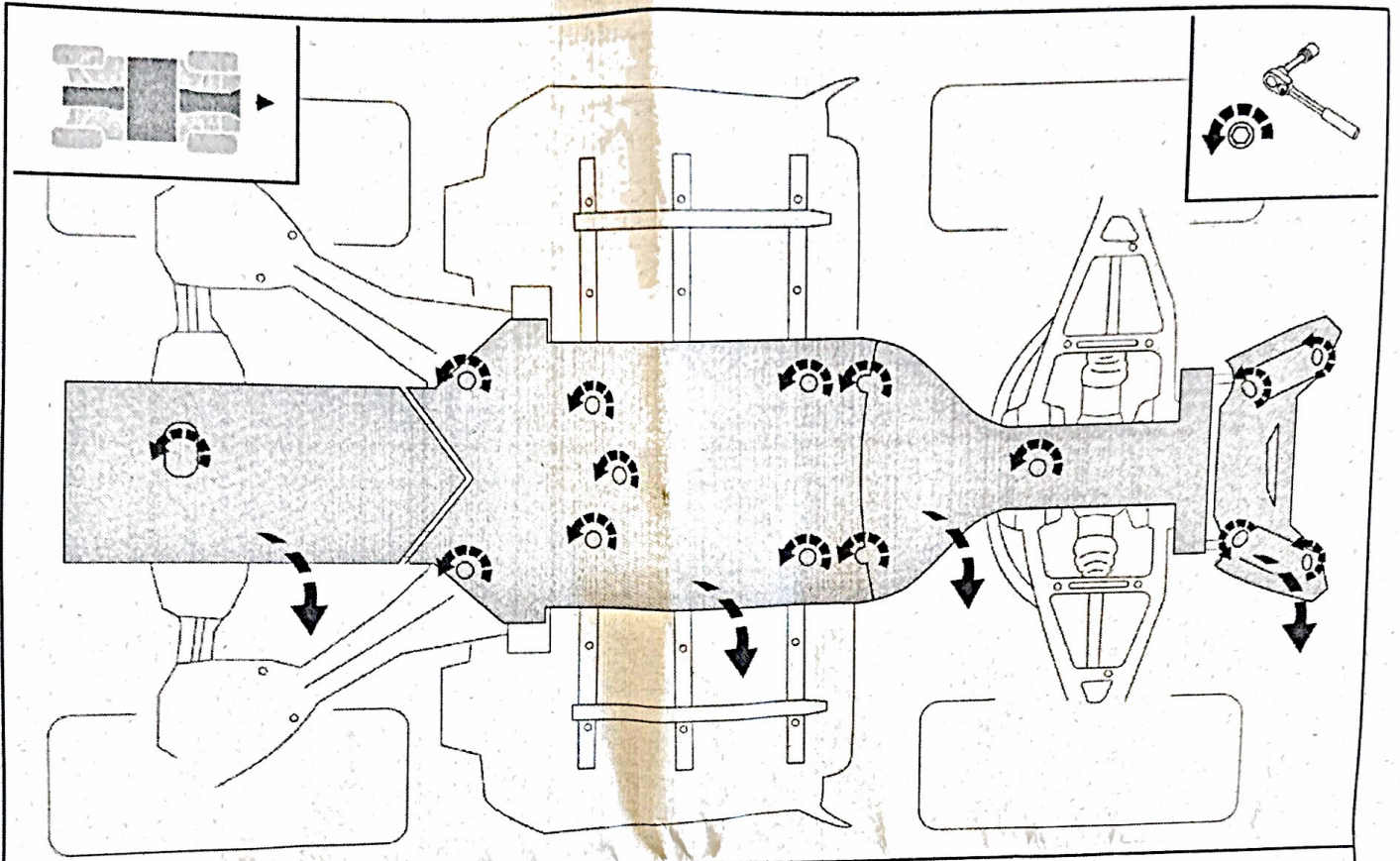

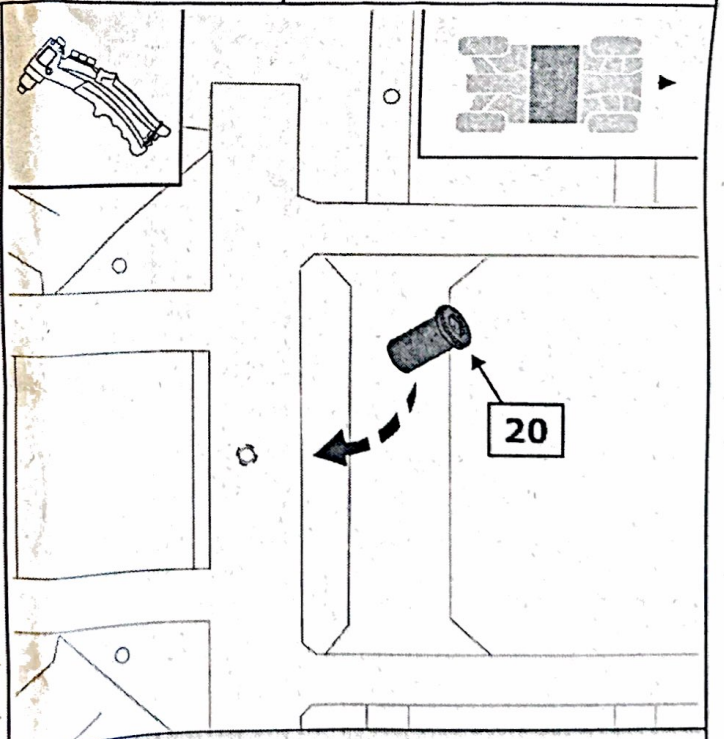
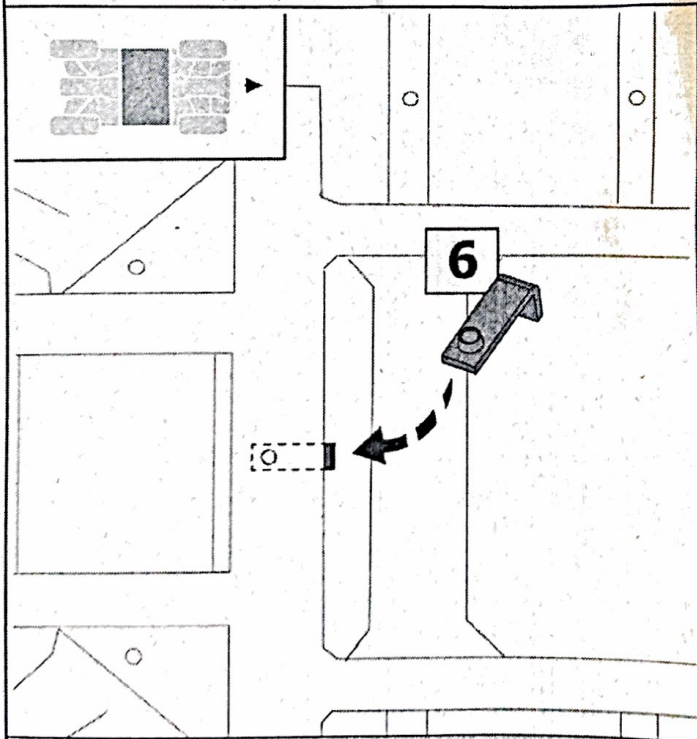
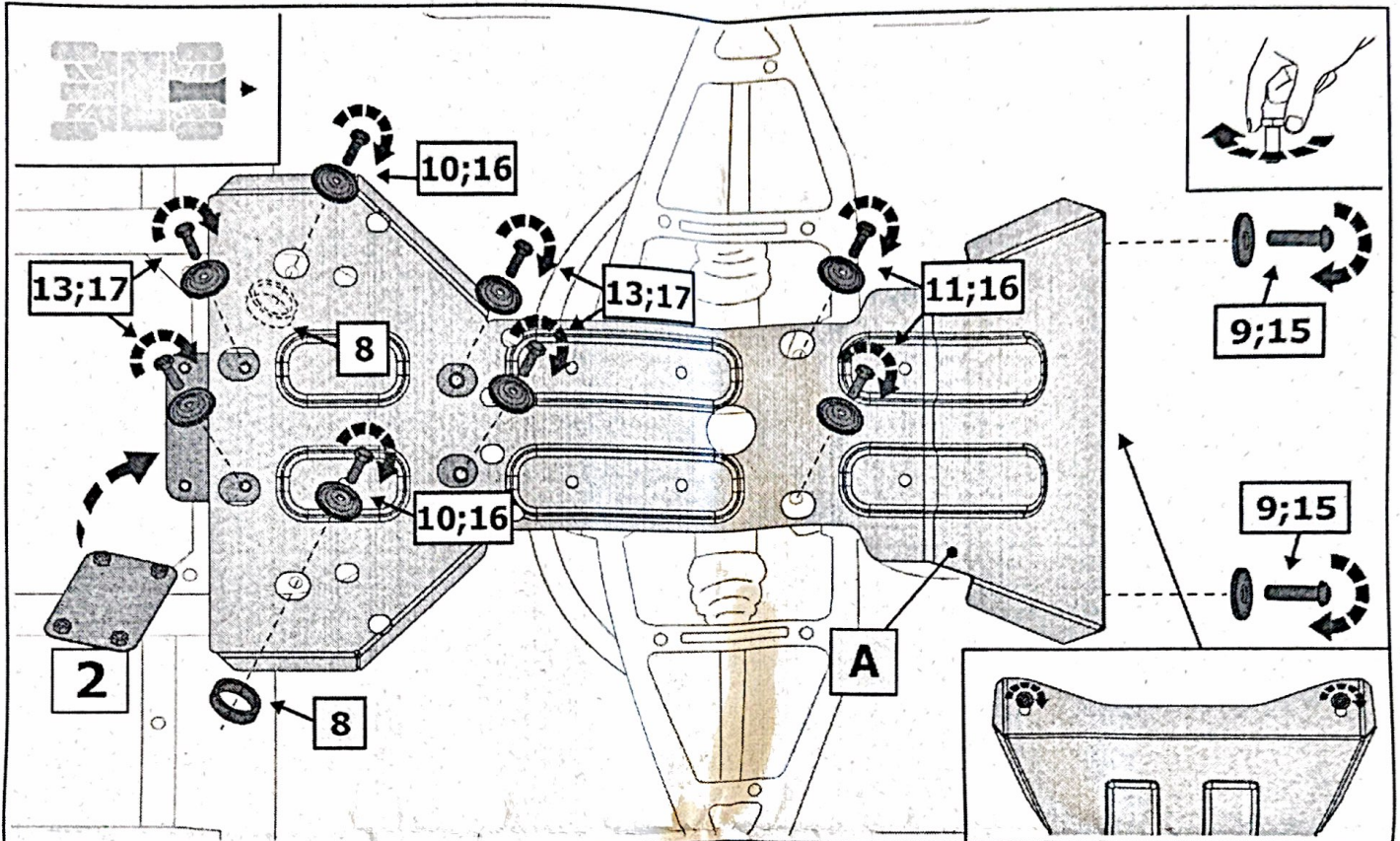

CF Moto X8 H.O. (2018-2021);
CF Moto X10 (2019-2021)

CF Moto X8 H.O. (2021-);
CF Moto X10 (2021-)

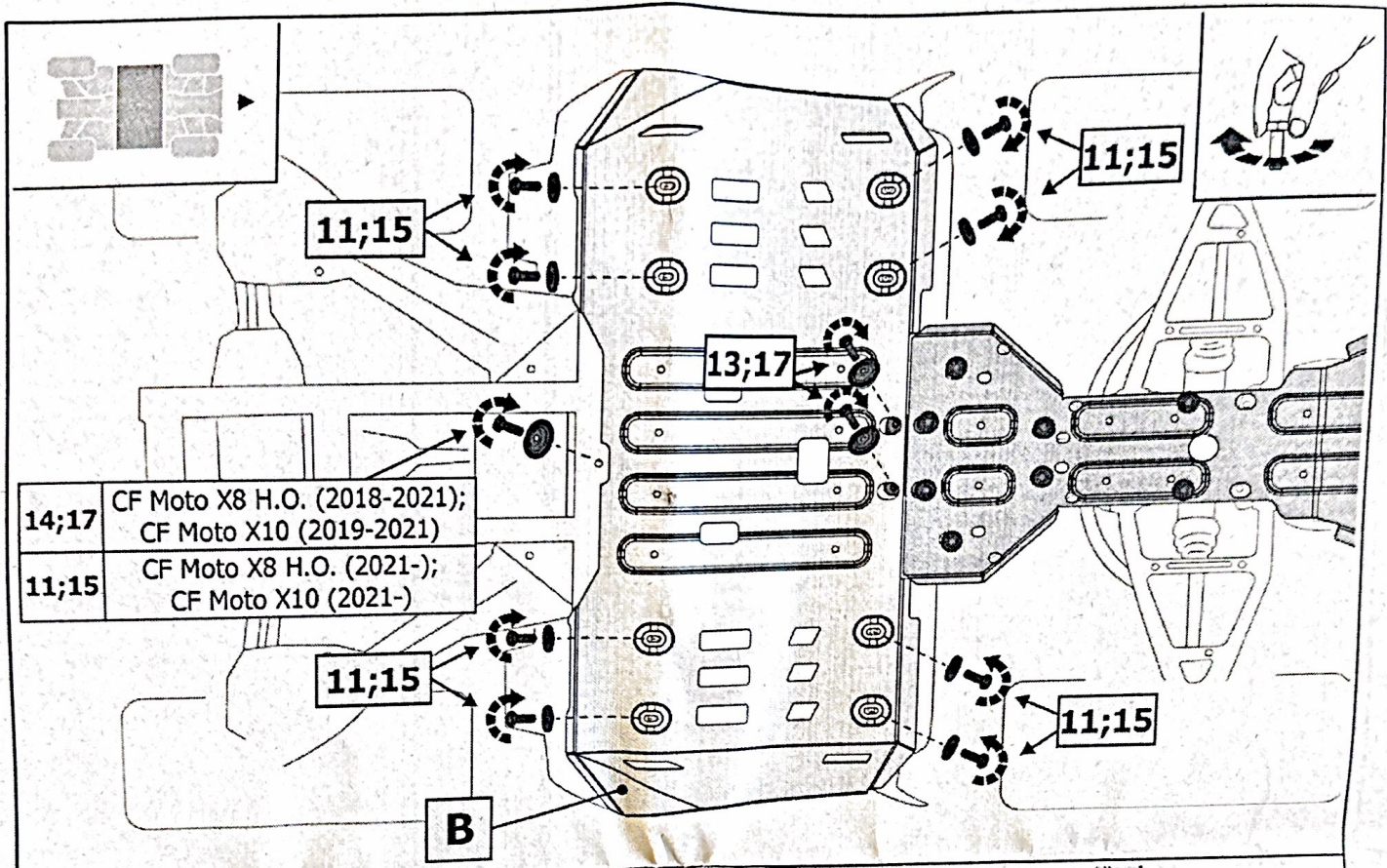

- | | |
|-------|---|
| 14;17 | CF Moto X8 H.O. (2018-2021);
CF Moto X10 (2019-2021) |
| 11;15 | CF Moto X8 H.O. (2021-);
CF Moto X10 (2021-) |

